

Article number: 25150462002

Description: ICME Single-phase motor MD90 L4 1,5KW
4 - 1400 rpm 1x230 Volt 50Hz B3 with starting & running capacitor

Measures

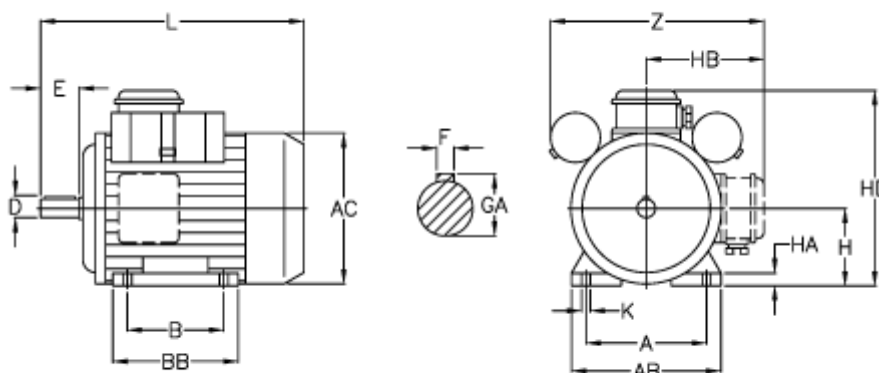

A = 140	H = 90
AB = 184	HA = 14
AC = 176	HB = 129
B = 125	K = 9
D = 24	L = 366
E = 50	Z = 246
F = 8	
GA = 27	